

Pressure transducers DMU 01 K Compact version

Part no. 31511

Pressure transducers



benefits

- proven ceramic technology
- no mechanical ageing of the measuring cell
- no transmission liquid
- Versions for relative pressure and absolute pressure
- small temperature error

Application

Electronic pressure measurement in industrial or HVAC applications such as hydraulic, pneumatic, automation, heating or air conditioning.

Description

Pressure transducers convert physical pressure into an electrical signal proportional to the pressure. DMU 01K is equipped with a piezo-resistive thick-film ceramic measuring cell.

Technical Specifications

Measuring range

0/1 bar

Process connection

G½B DIN 3852 type E

material

Housing: Stainless steel 304

pressure connection: Stainless steel 304

diaphragm: ceramic (Al₂O₃ 96 %)

Seal: FKM (Viton)

Supply voltage

DC 8 – 32 V

Output signal

2-wire, 4–20 mA

Electrical connection

Connector and junction box as per ISO 4400 (DIN 43650-A)

Degree of protection

IP 65 (EN 60529)

Options

- other connection threads
- fixed cable connection
- other connectors

- Output signal 0–10 V, 3-wire

Technical Drawings

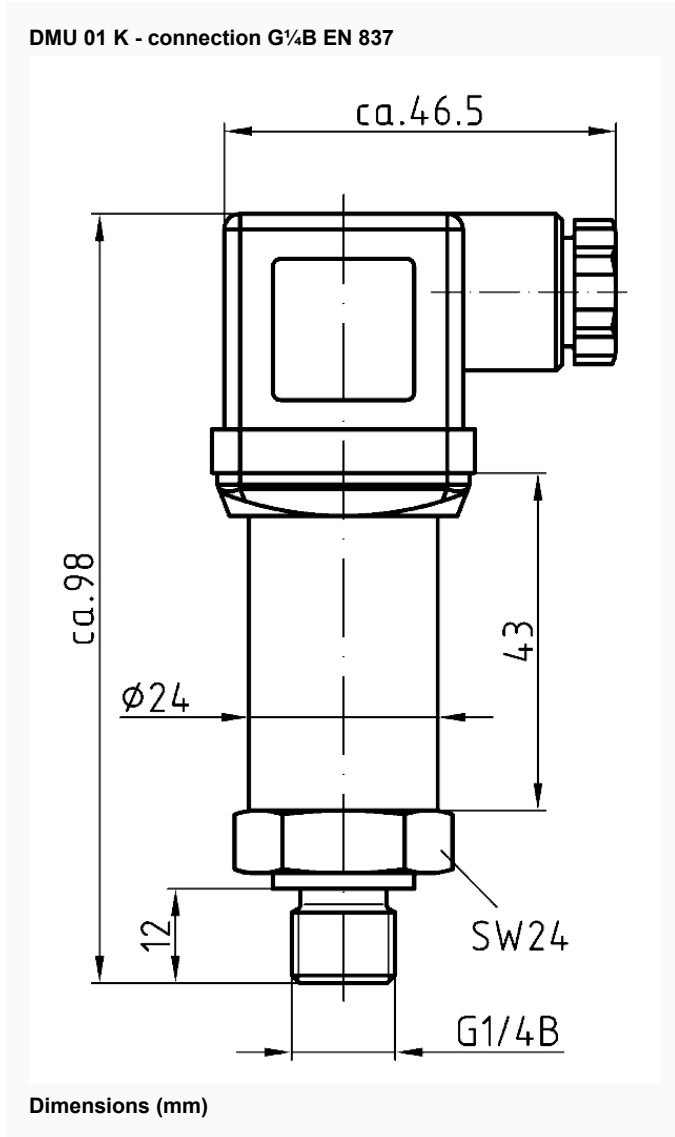

Versions

Range	Measuring range	Type	Version	Part no.
	0/1 bar		Compact version	31511

- in-stock items
- Non-stock items