



Profile pocket 1/2" 15 x 16 mm

Part no. 67338N

pockets for thermometers and thermostats with capillary tube

Technical Drawings

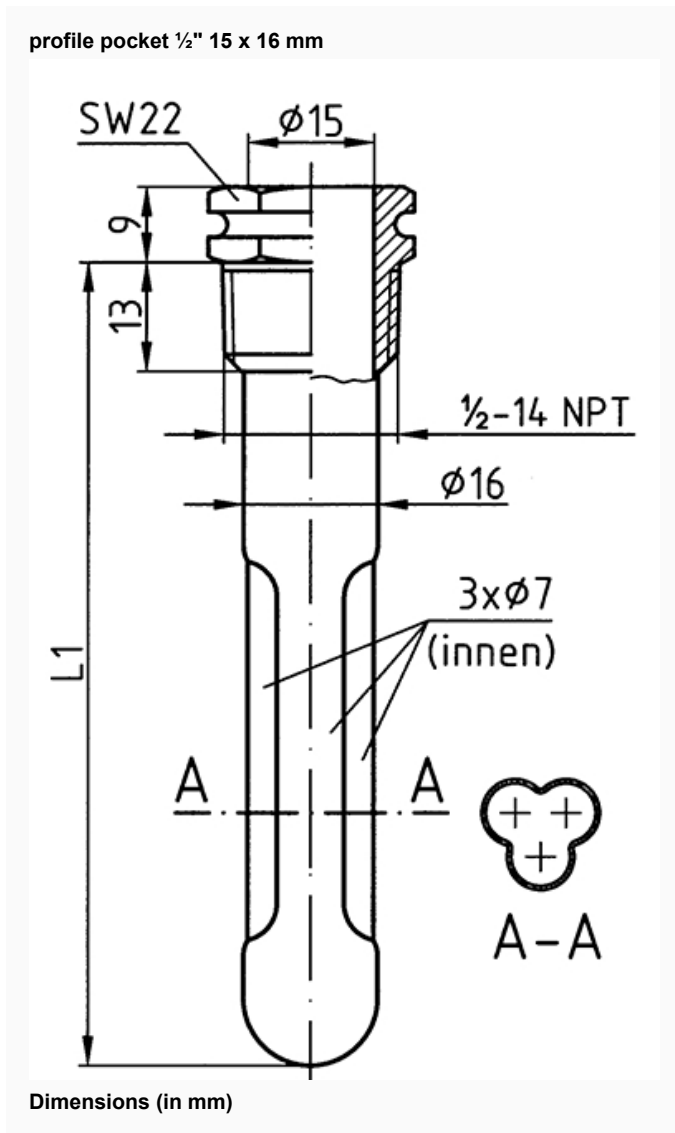

Versions

Type	material	stem		Stem length L1		Part no.
		inside ø	outside ø			
Profile pocket 1/2" 15 x 16 mm	Brass/Cu al- loy, bare metal surface	15 mm	16 mm	200 mm	●	67338N

- in-stock items
- Non-stock items