



## Precision Bourdon tube pressure gauges RF160F

Part no. 85714411

Precision Bourdon tube pressure gauges

### Application

For gaseous and liquid media which are not corrosive and not highly viscous and which do not crystallise. For high measuring accuracy.  
! For measuring gas or vapour, observe the table "Selection Criteria as per EN 837-2" (see appendix)!

### Technical Specifications

**Type**

D4

**Nominal size**

160

**accuracy class (EN 837-1/6)**

0.6

**ranges**

see ordering table

**Calibration medium**

≤ 40 bar

Air

**application area**

static load: Full scale value

dynamic load: 0.9 x full scale value

**Operating temperature range**

Medium: max. 60 °C

Ambient: -20/+60 °C

**Temperature performance**

Indication error when the temperature of the measuring system deviates from the normal temperature of 20 °C:

at rising temperature approx. ± 0.4 %/10 K

falling temperature approx. ± 0.4 %/10 K

of full scale value

**Degree of protection**

IP 54 (EN 60529)

**Connection**

Brass, bottom back

**Measuring element**

Bourdon tube

≤ 60 bar: "C" type tube, Copper alloy

> 60 bar: helical tube, stainless steel 316 Ti/316 L

**movement**

Brass/nickel silver, jewel bearing

**Dial**

Aluminium, white  
Scaling: black  
NG 160

**Pointer**

knife edge pointer  
Aluminium, black

**Housing**

Stainless steel 304

**bayonet bezel**

Stainless steel 304

**window**

Plastic (PMMA)

**Options**

- factory test certificates
- Glycerine filling (type D 8) > 2.5 bar
- wetted parts stainless steel (type D 4x2)
- laminated safety glass window
- back flange
- 3-hole fixing, panel mounting bezel
- throttle screw
- special scales
- other process connections

**Technical Drawings**

**NG 160 – bottom back connection**

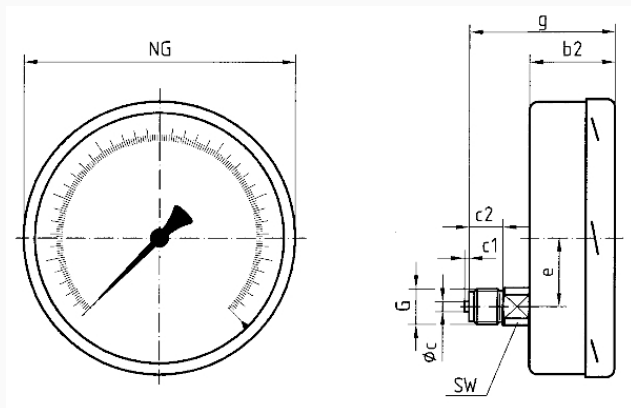

**Dimensions (mm)**

NG	b2	∅c	c1	c2	e	G	g	SW
160	50	6	3	20	44,5	G½B	82	22

## Versions

Range	Mounting type	Type		Part number
0/6 bar	direct	RF160F D411	<input type="radio"/>	85714411

- in-stock items
- Non-stock items