



Precision Bourdon tube pressure gauges RF160F

Part no. 85710411

Precision Bourdon tube pressure gauges

Application

For gaseous and liquid media which are not corrosive and not highly viscous and which do not crystallise. For high measuring accuracy.
! For measuring gas or vapour, observe the table "Selection Criteria as per EN 837-2" (see appendix)!

Technical Specifications

Type

D4

Nominal size

160

accuracy class (EN 837-1/6)

0.6

ranges

see ordering table

Calibration medium

≤ 40 bar

Air

application area

static load: Full scale value

dynamic load: 0.9 x full scale value

Operating temperature range

Medium: max. 60 °C

Ambient: -20/+60 °C

Temperature performance

Indication error when the temperature of the measuring system deviates from the normal temperature of 20 °C:

at rising temperature approx. ± 0.4 %/10 K

falling temperature approx. ± 0.4 %/10 K

of full scale value

Degree of protection

IP 54 (EN 60529)

Connection

Brass, bottom back

Measuring element

Bourdon tube

≤ 60 bar: "C" type tube, Copper alloy

> 60 bar: helical tube, stainless steel 316 Ti/316 L

movement

Brass/nickel silver, jewel bearing

Dial

Aluminium, white
Scaling: black
NG 160

Pointer

knife edge pointer
Aluminium, black

Housing

Stainless steel 304

bayonet bezel

Stainless steel 304

window

Plastic (PMMA)

Options

- factory test certificates
- Glycerine filling (type D 8) > 2.5 bar
- wetted parts stainless steel (type D 4x2)
- laminated safety glass window
- back flange
- 3-hole fixing, panel mounting bezel
- throttle screw
- special scales
- other process connections

Technical Drawings

NG 160 – bottom back connection

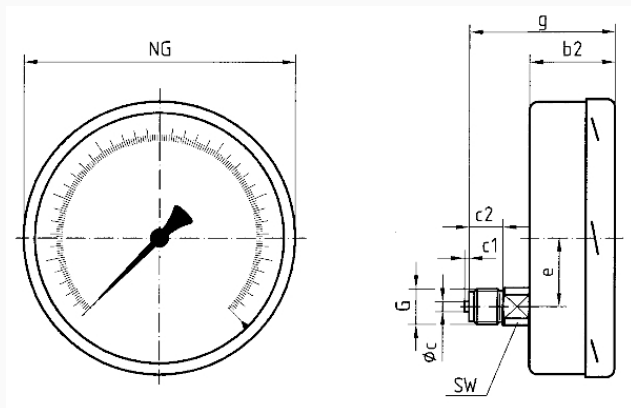

Dimensions (mm)

NG	b2	∅c	c1	c2	e	G	g	SW
160	50	6	3	20	44,5	G½B	82	22

Versions

Range	Mounting type	Type		Part number
0/1 bar	direct	RF160F D411	<input type="radio"/>	85710411

- in-stock items
- Non-stock items