



## Capsule pressure gauges for chemical applications KP160Ch

Part no. 35154412

Capsule pressure gauges for chemical applications Type D4

### benefits

- with zero correction
- robust stainless steel housing (with bayonet bezel)
- wetted parts and movement made of stainless steel
- GOSSTANDART-certified
- Ex version (optional)

### Application

For corrosive gaseous and dry media, also for use in corrosive environments.

### Technical Specifications

#### Type

D4

#### Nominal size

160

#### accuracy class (EN 837-3/6)

1.6

#### ranges (EN 837-3/5)

see ordering table

#### application area

static load: Full scale value  
dynamic load: 0.9 x full scale value  
overload safety: 1.3 x full scale value

#### Operating temperature range

Medium: max. 100 °C  
Ambient: -20/+60 °C

#### Temperature performance

Indication error when the temperature of the measuring system deviates from the normal temperature of 20 °C:  
at rising temperature approx.  $\pm 0.6 \%$ /10 K  
falling temperature approx.  $\pm 0.6 \%$ /10 K  
of full scale value

#### Degree of protection

IP 32 (EN 60529)

#### Connection

stainless steel 316 Ti/316 L, centre back

#### Measuring element

Capsule element, stainless steel 316 Ti/316 L

#### movement

Stainless steel

#### Zero correction

from the front

#### Seal

FKM (Viton)

**Dial**  
Aluminium, white  
Scaling: black

**Pointer**  
Aluminium, black

**Housing**  
Stainless steel 304

**bayonet bezel**  
Stainless steel 304

**window**  
D412  
Laminated safety glass

**Options**

- back flange
- Panel mounting bezel
- 3-hole fixing, panel mounting bezel
- Ex version
- throttle screw
- special scales
- other process connections

**Technical Drawings**

**Centre back connection**

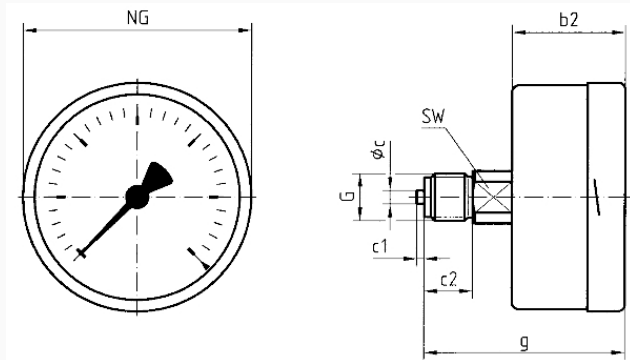

**Dimensions (mm)**

NG	b2	Øc	c1	c2	G	g	SW
63	37	5	2	13	G¼B	60	14
100	49	6	3	20	G½B	81	22
160	50	6	3	20	G½B	84	22

**Versions**

Range	Mounting type	Type	Part number
-25/+0 mbar	direct	KP160Ch D412	35154412

- in-stock items
- Non-stock items