



## Standard capsule pressure gauges KP63

Part no. 35012431

Standard capsule pressure gauges Type D4

### benefits

- with zero correction
- optional overpressure and/or underpressure safety 10 x FSD
- extremely low measuring ranges from 0/6 mbar
- GOSSTANDART-certified

### Application

For gaseous, dry media which do not attack copper alloys.

! For measuring gas or vapour, observe the table "Selection Criteria as per EN 837-2" (see appendix)!

### Technical Specifications

#### Type

D4

#### Nominal size

63

#### accuracy class (EN 837-3/6)

1.6

#### ranges (EN 837-3/5)

see ordering table

#### application area

static load: Full scale value  
dynamic load: 0.9 x full scale value  
overload safety: 1.3 x full scale value

#### Operating temperature range

Medium: max. 60 °C  
Ambient: -20/+60 °C

#### Temperature performance

Indication error when the temperature of the measuring system deviates from the normal temperature of 20 °C:  
at rising temperature approx.  $\pm 0.6 \%$ /10 K  
falling temperature approx.  $\pm 0.6 \%$ /10 K  
of full scale value

#### Degree of protection

NG 63  
IP 33 (EN 60529)

#### Connection

Brass, centre back

#### Measuring element

Capsule element, CuBe alloy

#### movement

Brass

#### Zero correction

from the front

**Seal**  
NBR (Perbunan)

**Dial**  
Aluminium, white  
Scaling: black

**Pointer**  
Aluminium, black

**Housing**  
Stainless steel 304

**bayonet bezel**  
Stainless steel 304

**window**  
D431  
Plastic (PMMA)

**Options**

- overpressure and underpressure safety 10 x FSD
- back flange
- Panel mounting bezel, with window, plastic
- 3-hole fixing, panel mounting bezel with window, plastic
- throttle screw
- Reference pointer
- special scales
- other process connections

**Technical Drawings**

**Centre back connection, 3-hole fixing, panel mounting bezel**

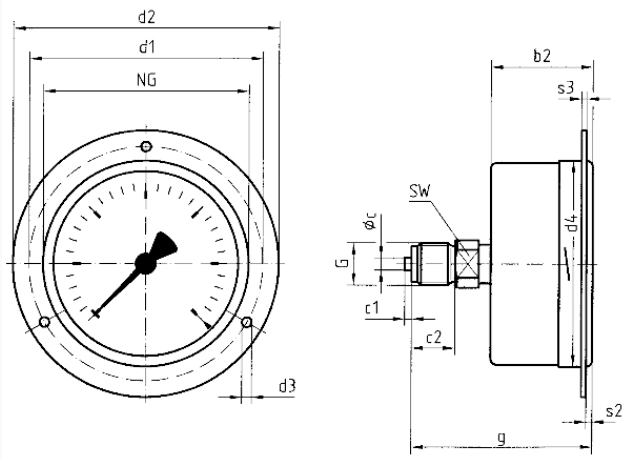

**Dimensions (mm)**

NG	b2	∅c	c1	c2	d1*	d2	d3*	d4	G	g	s2	s3	SW
63	37	5	2	13	75	85	3,5	64	G1/4B	60	3	2	14
100	49	6	3	20	116	132	4,8	104	G1/2B	81	4	2	22
160	50	6	3	20	178	196	5,8	164	G1/2B	82	4	2	22

\* Dimensions for NG 100 according to DIN 16014

## Versions

Range	Mounting type	Type		Part number
-1000/+0 mbar	3-hole fixing, panel mounting bezel	KP63 D431	●	35012431

- in-stock items
- Non-stock items