



Standard capsule pressure gauges KP80

Part no. 35061331

Standard capsule pressure gauges Type D3

benefits

- with zero correction
- ideal for low pressure ranges
- GOSSTANDART-certified

Application

For gaseous, dry media which do not attack copper alloys.

! For measuring gas or vapour, observe the table "Selection Criteria as per EN 837-2" (see appendix)!

Technical Specifications

Type

D3

Nominal size

80

accuracy class (EN 837-3/6)

1.6

ranges (EN 837-3/5)

see ordering table

application area

static load: Full scale value
dynamic load: 0.9 x full scale value
overload safety: 1.3 x full scale value

Operating temperature range

Medium: max. 60 °C
Ambient: -20/+60 °C

Temperature performance

Indication error when the temperature of the measuring system deviates from the normal temperature of 20 °C:
at rising temperature approx. $\pm 0.6 \%$ /10 K
falling temperature approx. $\pm 0.6 \%$ /10 K
of full scale value

Degree of protection

NG 80
IP 33 (EN 60529)

Connection

Brass, centre back

Measuring element

Capsule element, CuBe alloy

movement

Brass

Zero correction

from the front

Seal
NBR (Perbunan)

Dial
Aluminium, white
Scaling: black

Pointer
Aluminium, black

Housing
Stainless steel 304

window
Plastic, clipped in

Options

- back flange
- Panel mounting bezel
- 3-hole fixing, panel mounting bezel
- Measuring system stainless steel (NG 100)
- throttle screw
- Reference pointer
- special scales
- other process connections

Technical Drawings

Centre back connection, 3-hole fixing, panel mounting bezel

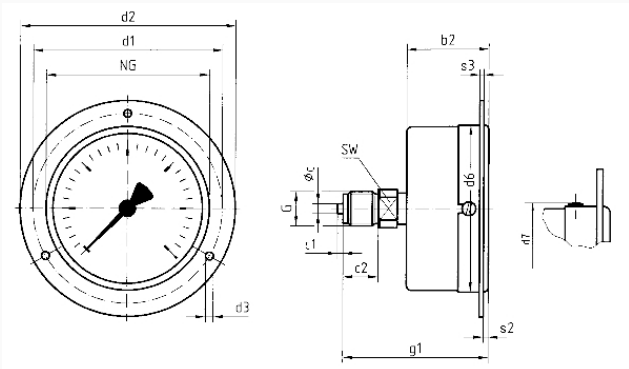

Dimensions (mm)

NG	b2	Øc	c1	c2	d1*	d2	d3*	d6	d7	G	g1	s2	s3	SW
63	35,7	5	2	13	75	85	3,5	64	66	G¼B58,7	3	2	14	
80	44,6	6	3	20	95	110	4,8	81	83	G½B76,6	3,5	2	22	
100	45,6	6	3	20	116	132	4,8	101	105	G½B77,6	3,5	2	22	

* Dimensions for NG 100 according to DIN 16014

Versions

Range	Mounting type	Type		Part number
-600/+0 mbar	3-hole fixing, panel mounting bezel	KP80 D331	●	35061331

- in-stock items
- Non-stock items