



## Standard capsule pressure gauges KP80

Part no. 35060331

Standard capsule pressure gauges Type D3

### benefits

- with zero correction
- ideal for low pressure ranges
- GOSSTANDART-certified

### Application

For gaseous, dry media which do not attack copper alloys.

! For measuring gas or vapour, observe the table "Selection Criteria as per EN 837-2" (see appendix)!

### Technical Specifications

#### Type

D3

#### Nominal size

80

#### accuracy class (EN 837-3/6)

1.6

#### ranges (EN 837-3/5)

see ordering table

#### application area

static load: Full scale value

dynamic load: 0.9 x full scale value

overload safety: 1.3 x full scale value

#### Operating temperature range

Medium: max. 60 °C

Ambient: -20/+60 °C

#### Temperature performance

Indication error when the temperature of the measuring system deviates from the normal temperature of 20 °C:

at rising temperature approx.  $\pm 0.6 \%$ /10 K

falling temperature approx.  $\pm 0.6 \%$ /10 K

of full scale value

#### Degree of protection

NG 80

IP 33 (EN 60529)

#### Connection

Brass, centre back

#### Measuring element

Capsule element, CuBe alloy

#### movement

Brass

#### Zero correction

from the front

**Seal**  
NBR (Perbunan)

**Dial**  
Aluminium, white  
Scaling: black

**Pointer**  
Aluminium, black

**Housing**  
Stainless steel 304

**window**  
Plastic, clipped in

**Options**

- back flange
- Panel mounting bezel
- 3-hole fixing, panel mounting bezel
- Measuring system stainless steel (NG 100)
- throttle screw
- Reference pointer
- special scales
- other process connections

**Technical Drawings**

**Centre back connection, 3-hole fixing, panel mounting bezel**

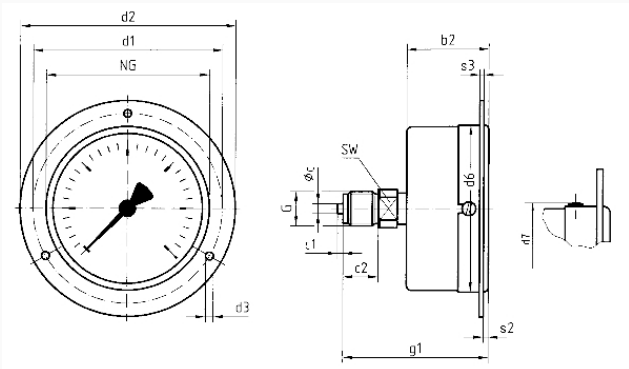

**Dimensions (mm)**

NG	b2	Øc	c1	c2	d1*	d2	d3*	d6	d7	G	g1	s2	s3	SW
63	35,7	5	2	13	75	85	3,5	64	66	G¼B58,7	3	2	14	
80	44,6	6	3	20	95	110	4,8	81	83	G½B76,6	3,5	2	22	
100	45,6	6	3	20	116	132	4,8	101	105	G½B77,6	3,5	2	22	

\* Dimensions for NG 100 according to DIN 16014

## Versions

Range	Mounting type	Type		Part number
-400/+0 mbar	3-hole fixing, panel mounting bezel	KP80 D331	●	35060331

● in-stock items

● Non-stock items