

Standard capsule pressure gauges KP80

Part no. 35067201

Standard capsule pressure gauges Type D2

benefits

- with zero correction
- ideal for low pressure ranges
- GOSSTANDART-certified

Application

For gaseous, dry media which do not attack copper alloys.

! For measuring gas or vapour, observe the table "Selection Criteria as per EN 837-2" (see appendix)!

Technical Specifications

Type

D2

Nominal size

80

accuracy class (EN 837-3/6)

1.6

ranges (EN 837-3/5)

see ordering table

application area

static load: Full scale value
dynamic load: 0.9 x full scale value
overload safety: 1.3 x full scale value

Operating temperature range

Medium: max. 60 °C
Ambient: -20/+60 °C

Temperature performance

Indication error when the temperature of the measuring system deviates from the normal temperature of 20 °C:
at rising temperature approx. $\pm 0.6 \%$ /10 K
falling temperature approx. $\pm 0.6 \%$ /10 K
of full scale value

Degree of protection

NG 80
IP 33 (EN 60529)

Connection

Brass, bottom

Measuring element

Capsule element, CuBe alloy

movement

Brass

Zero correction

from the front

Seal

NBR (Perbunan)

Dial

 Aluminium, white
 Scaling: black

Pointer

Aluminium, black

Housing

Sheet steel, black

window

Plastic, clipped in

Options

- back flange
- 3-hole fixing, panel mounting bezel
- Measuring system stainless steel (NG 100)
- throttle screw
- Reference pointer
- special scales
- other process connections

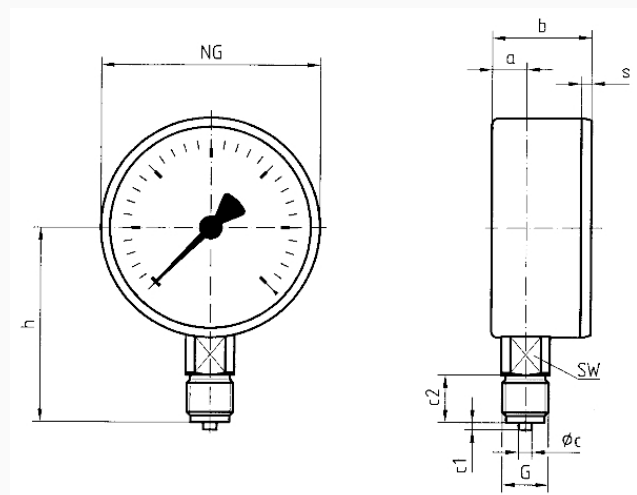
Technical Drawings
Bottom connection

Dimensions (mm)

NG	a	b	Øc	c1	c2	G	h	s	SW
63	9,5	33,7	5	2	13	G¼B	52,7	3,7	14
80	14,8	43,3	6	3	20	G½B	69	3,8	22
100	15,6	44	6	3	20	G½B	87	3,5	22

Versions

Range	Mounting type	Type		Part number
0/40 mbar	direct	KP80 D201	<input checked="" type="radio"/>	35067201

- in-stock items
- Non-stock items