



## Standard capsule pressure gauges KP63

Part no. 35022201

Standard capsule pressure gauges Type D2

### benefits

- with zero correction
- ideal for low pressure ranges
- GOSSTANDART-certified

### Application

For gaseous, dry media which do not attack copper alloys.

! For measuring gas or vapour, observe the table "Selection Criteria as per EN 837-2" (see appendix)!

### Technical Specifications

#### Type

D2

#### Nominal size

63

#### accuracy class (EN 837-3/6)

1.6

#### ranges (EN 837-3/5)

see ordering table

#### application area

static load: Full scale value

dynamic load: 0.9 x full scale value

overload safety: 1.3 x full scale value

#### Operating temperature range

Medium: max. 60 °C

Ambient: -20/+60 °C

#### Temperature performance

Indication error when the temperature of the measuring system deviates from the normal temperature of 20 °C:

at rising temperature approx.  $\pm 0.6 \%$ /10 K

falling temperature approx.  $\pm 0.6 \%$ /10 K

of full scale value

#### Degree of protection

NG 63

IP 33 (EN 60529)

#### Connection

Brass, bottom

#### Measuring element

Capsule element, CuBe alloy

#### movement

Brass

#### Zero correction

from the front

**Seal**  
NBR (Perbunan)

**Housing**  
Sheet steel, black

**Dial**  
Aluminium, white  
Scaling: black

**window**  
Plastic, clipped in

**Pointer**  
Aluminium, black

**Options**

- back flange
- 3-hole fixing, panel mounting bezel
- Measuring system stainless steel (NG 100)
- throttle screw
- Reference pointer
- special scales
- other process connections

**Technical Drawings**

**Bottom connection**

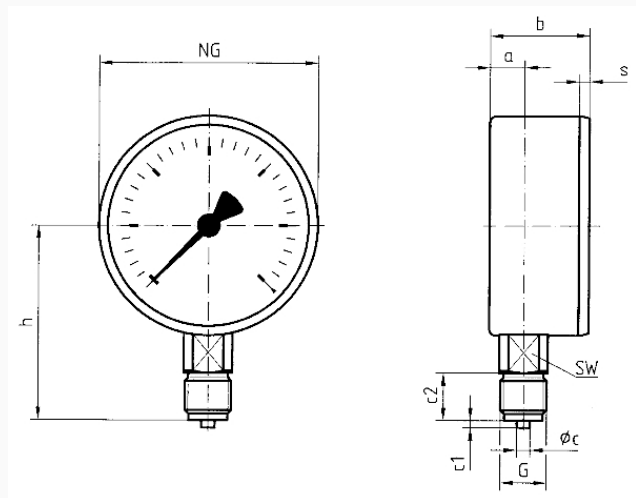

**Dimensions (mm)**

NG	a	b	Øc	c1	c2	G	h	s	SW
63	9,5	33,7	5	2	13	G¼B	52,7	3,7	14
80	14,8	43,3	6	3	20	G½B	69	3,8	22
100	15,6	44	6	3	20	G½B	87	3,5	22

## Versions

Range	Mounting type	Type		Part number
0/400 mbar	direct	KP63 D201	<input checked="" type="radio"/>	35022201

- in-stock items
- Non-stock items