



bimetal stainless steel thermometer BiTh 100 E

Part no. 66354312

bimetal stainless steel thermometer BiTh E

benefits

- suitable for use in mechanical engineering, plant engineering, process engineering or food industry
- ideal for hygienic processes
- accuracy class 1 as per EN 13190
- for temperatures of the medium of up to 160 °C
- with adapter ring for thermowell Ø 18 mm

Application

For corrosive media. Suitable for a great range of industrial applications.

Technical Specifications

Type
D3

Nominal size
100

measuring element
Bimetal helix

accuracy class
1 (EN 13190)

ranges °C
0/160

Application area (EN 13190)
continuous load: Measuring range
short-term: Range

Operating pressure at thermowell
(not included in scope of delivery)
max. 25 bar

Options

- Thermowell G $\frac{1}{2}$ B, stainless steel 316 Ti/316 L

Degree of protection
IP 43 (EN 60529)

Connection
Stem: Stainless steel 316 L, Ø 8 mm
Stem: plain

mounting position
centre back

Dial
Aluminium, white
Scaling: black

Pointer
Aluminium, black

Housing
Stainless steel 304

push on bezel
Stainless steel 304

window
Instrument glass

- other connection designs
- other ranges
- other stem lengths

Technical Drawings

centre back connection, plain

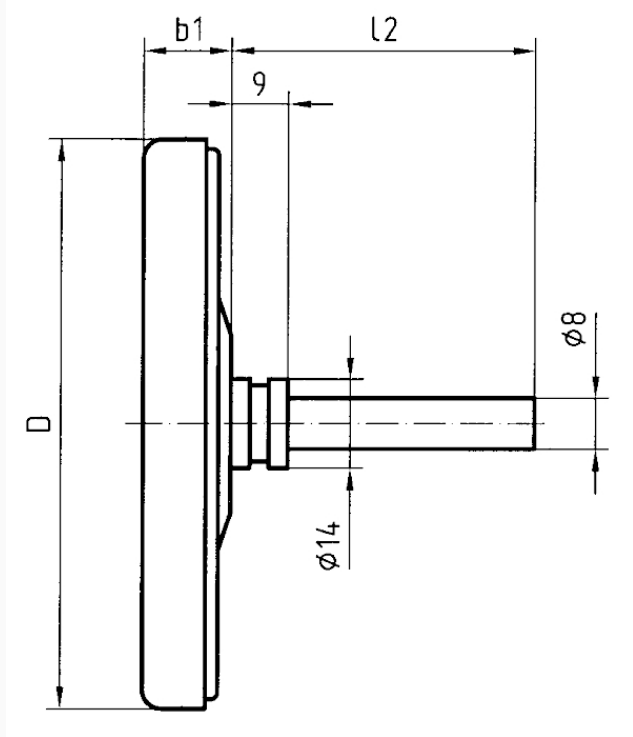

Dimensions (mm)

NG	b1	D	l2
63	15	63	67
63	15	63	104
63	15	63	154
63	15	63	204
80	15	80	67
80	15	80	104
80	15	80	154
80	15	80	204
100	17	100	67
100	17	100	104
100	17	100	154
100	17	100	204

Versions

Type	housing ø	moun- ting po- sition	Connec- tion	Range	For ther- mowell with length L1	Stem length L1	Type	Type	Part no.
BiTh 100 E	100 mm	centre back	plain	0/160 °C	150 mm		BiTh 100 E	D312	● 66354312

● in-stock items

● Non-stock items